



RX-4508

AM/FM STEREO RECEIVER

OPERATING INSTRUCTIONS

Safety Information

READ THIS BEFORE OPERATING YOUR UNIT



CAUTION
RISK OF ELECTRIC SHOCK
DO NOT OPEN



CAUTION
TO REDUCE THE RISK OF ELECTRIC SHOCK,
DO NOT REMOVE FRONT OR BACK COVER.
NO USER-SERVICEABLE PARTS INSIDE.
REFER SERVICING TO QUALIFIED SERVICE
PERSONNEL.

CE R&TTE Directive 1999/5/EC



This symbol indicates the presence of uninsulated "dangerous voltage" within the product's enclosure that may be of sufficient magnitude to constitute a risk of electric shock.



This symbol indicates important operating and maintenance (servicing) instructions in the literature accompanying the appliance.

WARNING: TO REDUCE THE RISK OF FIRE OR ELECTRIC SHOCK, DO NOT EXPOSE THIS APPLIANCE TO RAIN OR MOISTURE.

CAUTION

- Leave space around the unit for sufficient ventilation.
- Avoid installation in extremely hot or cold locations, or in an area that is exposed to direct sunlight or heating equipment.
- Keep the unit free from moisture, water, and dust.
- Do not let foreign objects in the unit.
- Keep the ventilation openings clear of items, such as newspapers, linens, or curtains.
- Keep open flame from candles or other sources away from the unit.
- Observe the local regulations regarding disposal of packaging materials, exhausted batteries and old equipment.
- Do not expose the unit to dripping or splashing, or place objects filled with liquids such as vases.

- Do not let insecticides, benzene, or thinner come in contact with the unit.
- Never disassemble or modify the unit in any way.

Notes on the AC power cord and the wall outlet

- The unit remains connected to AC power as long as it is plugged into the wall outlet, even if the unit has been turned off.
- To completely disconnect this product from AC power, disconnect the plug from the wall socket outlet.
- When setting up this product, make sure that the AC outlet you are using is easily accessible.
- Disconnect the plug from the wall outlet when not using the unit for long periods of time.

Caution regarding installation

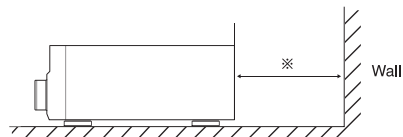
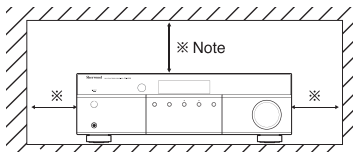

Do not block ventilation openings or stack other equipment on the top.

※ **Note:** For heat dispersal, do not install this unit in a confined space such as a bookcase or similar enclosure.

Table of Contents

2 SAFETY INFORMATION

3 TABLE OF CONTENTS

4 GETTING STARTED

- 4 What's Included
- 5 Installing the Remote Control Battery
- 5 Operating the Range of the Remote Control

6 PARTS DESCRIPTION

- 6 Front Panel
- 7 Front Display
- 7 Rear Panel
- 8 Remote Control

9 MAKING CONNECTIONS

- 9 Connecting Speakers
 - 9 Placing Speakers
 - 9 Connecting Speakers
- 11 Connecting Playback Components
 - 11 Connecting Audio Components
 - 12 Connecting Recording Components
- 13 Connecting an Antenna
 - 13 Connecting FM Antenna
 - 14 Connecting AM Antenna
- 15 Connecting Power

16 OPERATING YOUR SYSTEM

- 16 Listening to Your System
 - 16 Basic Operation
 - 17 Muting the Sound
 - 17 Adjusting the Sound Balance (Left and Right)
 - 17 Adjusting the Tone (Bass and Treble)
 - 18 Listening to Radio
 - 18 Selecting the Band
 - 18 Manual Tuning
 - 18 Auto Tuning
 - 18 Manual Presetting
 - 19 Auto Presetting
 - 20 Tuning in to Preset Stations
 - 20 Scanning Preset Stations in Sequence
 - 20 Switching FM Stereo/Mono Mode
 - 21 Bluetooth
 - 21 Pairing with the Bluetooth Device
 - 21 Listening to Music on Device
 - 22 Recording
 - 23 Using Other Functions
 - 23 Setting the Sleep Timer
 - 23 Setting the Auto Power Control
 - 23 Adjusting the Brightness of the Fluorescent Display
- ## 24 TROUBLESHOOTING
-
- 24 GENERAL
 - 24 SOUND

25 ADDITIONAL INFORMATION

- 25 Specifications
- 26 Trademarks and Licenses

Getting Started

What's Included

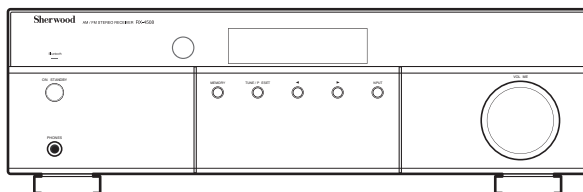

Main unit



Remote control (1 ea)

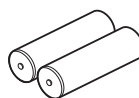

Battery

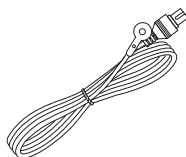

FM Antenna (1 ea)



AM Antenna (1 ea)



User Manual (1 ea)



Warranty (1 ea)

Installing the Remote Control Battery

1 Remove the battery cover.

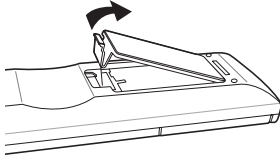

2 Insert two AAA size batteries with the polarity matched properly.

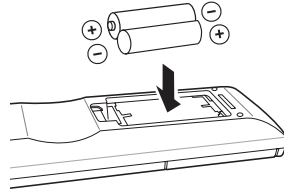

Caution

- Always use alkaline batteries, and do not use the rechargeable batteries (Ni-Cd type).
- If the batteries run out, remove the old batteries and replace them with new ones within several minutes.
- If the batteries are removed or have been exhausted for a longer period of time, memorized contents will be cleared. In this case, you should memorize them again.
- If the battery is placed incorrectly, it can cause explosion.
- Remove the battery if the remote control is not used for a long period of time.
- Do not leave the product in a hot or humid place.
- Do not handle and store the battery with metallic tools.

Operating the Range of the Remote Control

Use the remote control within a range of about 7 meters (23 feet) and angles of up to 30 degrees aiming at the remote control sensor.

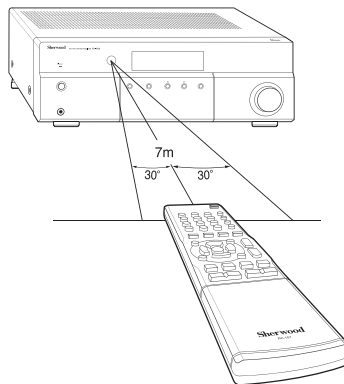

Parts Description

Front Panel

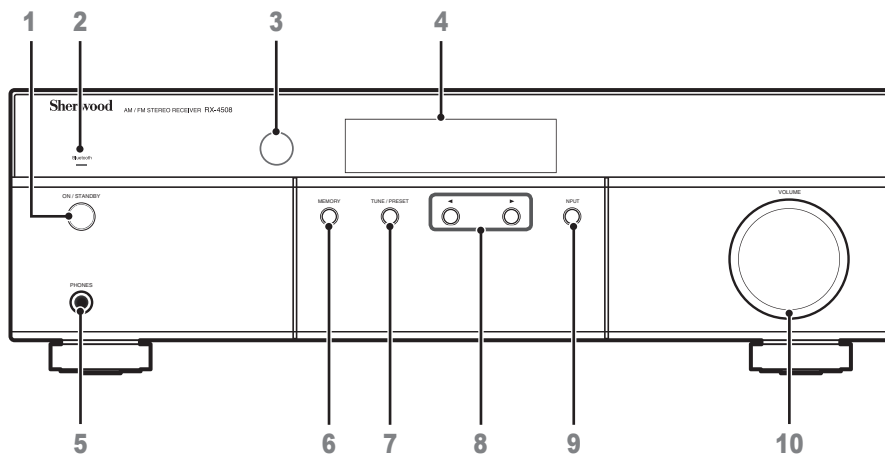

- 1 ON/STANDBY Button
- 2 Bluetooth Indicator
- 3 IR Sensor
- 4 Display
- 5 Headphone Connector
- 6 Memory Button
- 7 Tune/Preset Select Button
- 8 Function Buttons
 - Tuning Up/Down - See page 18.
 - Preset Up/Down - See page 18.
 - Auto Tuning - See page 18.
 - Bluetooth Playback Control - See page 21.
- 9 Input Selector
- 10 Volume Control

Front Display

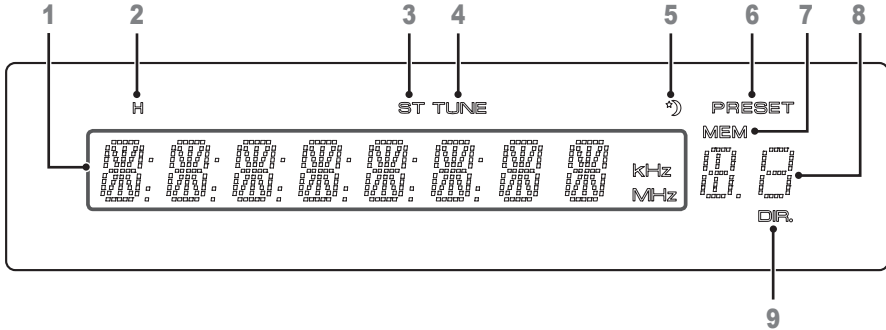

- | | |
|--|---|
| <ul style="list-style-type: none"> 1 Information Display 2 Headphone Indicator 3 Stereo Indicator 4 Tuned indicator 5 Sleep Timer Indicator | <ul style="list-style-type: none"> 6 Preset Indicator 7 Station Memory Indicator 8 Preset Station Indicator 9 Tone Direct Indicator |
|--|---|

Rear Panel

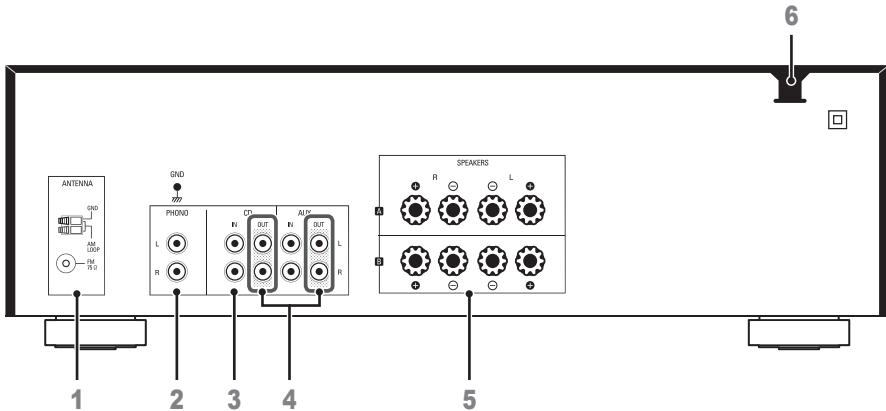

- | | |
|--|--|
| <ul style="list-style-type: none"> 1 Radio Antenna Connectors 2 Phono Connectors 3 Audio Input Connectors | <ul style="list-style-type: none"> 4 Audio Output Connectors 5 Speaker Connectors 6 AC Input Cord |
|--|--|

Remote Control

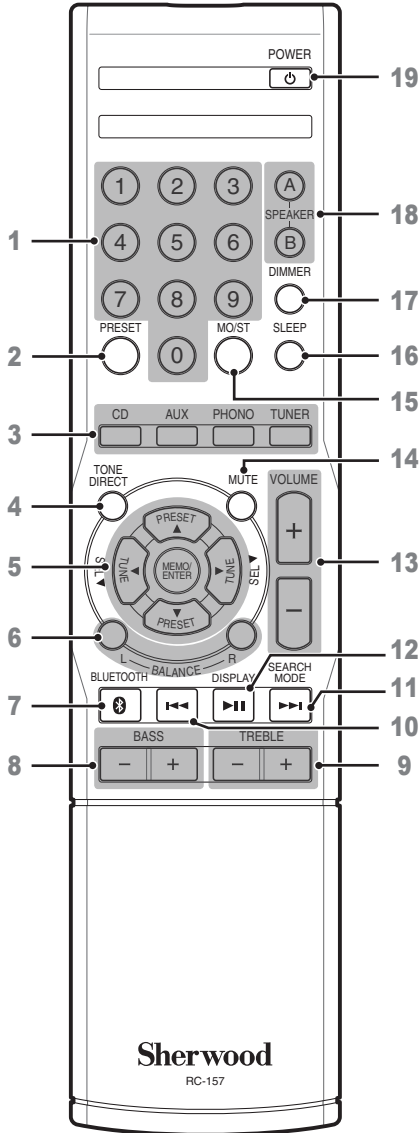

- 1 Numeric Buttons
- 2 Preset Button
- 3 Source Select Buttons
- 4 Tone Control Button
- 5 ▲/▼ Preset Up/Down Buttons
◀/▶ Tuning Up/Down Buttons
- MEMO/ENTER** Memory/Enter Button
- 6 Balance Adjust Buttons
- 7 Bluetooth Button
- 8 Bass Up/Down Buttons
- 9 Treble Up/Down Buttons
- 10 ◀◀ Bluetooth Previous/Rewind Button
- 11 ▶▶ Bluetooth Next/Fast Forward Button
- 12 ▶|| Bluetooth Play/Pause Button
- 13 Volume Up/Down Buttons
- 14 Mute Button
- 15 Mono/Stereo Select Button
- 16 Sleep Button
- 17 Dimmer Button
- 18 Speaker Select Button
- 19 Power Button

Making Connections

Connecting Speakers

Placing Speakers

Determine the locations for your speaker placement according to their manufacturer's directions and the layout of your listening room.

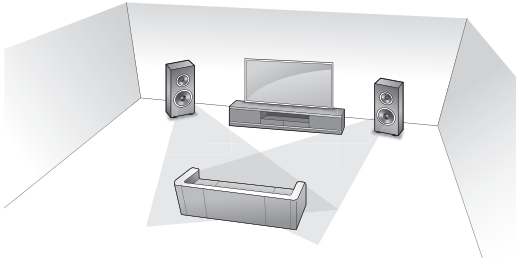

Left and right speakers

- Place the speakers with their front surfaces as flush to the TV or monitor screen as possible.
- Place each speaker so that sound is aimed at where listener's ears would be in the main listening position.

Connecting Speakers

Carefully check the left (L) and right (R) channels and the polarities on the speakers being connected to this receiver.

Connecting Speaker Wires

- 1** Strip away approx. 10 mm (3/8 inch) of wire insulation, and then tightly twist the wire ends.



- 3** Insert the bare part of the wire.



- 2** Loosen the speaker terminal by turning it counter-clockwise.



- 4** Tighten the speaker terminal by turning it clockwise.



RX-4508 AM/FM STEREO RECEIVER

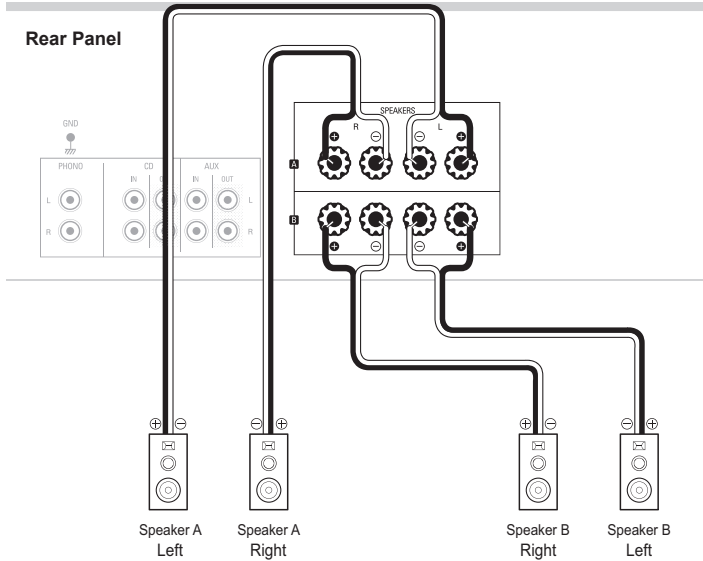

- Be sure to connect speakers firmly and accurately according to the channel (left and right) and the polarity (+ and -). If the connections are incorrect, no sound will be produced by the speakers, and if the polarity of the speaker connection is incorrect, the sound will be unnatural and tinny.



Caution

- Be sure to use the speakers with the impedance of 8 ohms or above.
- Do not let bare speaker wires touch each other or any metal part of this receiver. This could damage the main unit and/or the speakers.
- Never touch the speaker terminals while the AC input cord is connected to the wall AC outlet. Doing so could result in electric shock.

Connecting Playback Components

Source devices are components from which a playback signal originates, e.g., a Blu-ray Disc™ or DVD player; a set-top box, or HDTV tuner, etc.

Connecting Audio Components

Audio Connection

Make audio connections from your source devices.

- Ensure the left (L) and right (R) channels and the inputs and outputs are correctly connected.
- To listen to the sound of a connected audio device, select AUX as the input source.

Rear Panel

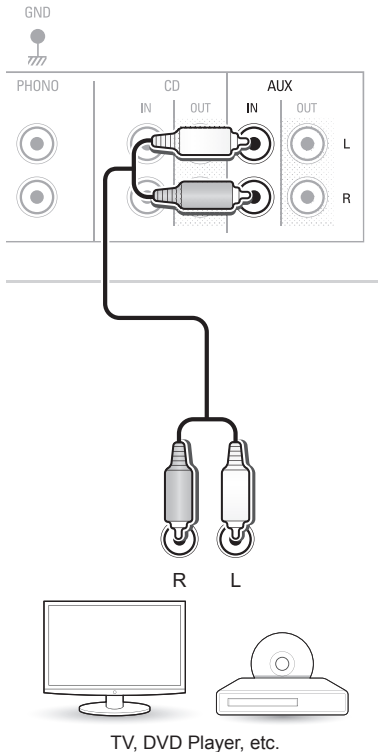

Phono Connection

You can use the PHONO input jack to connect turntable.

Rear Panel

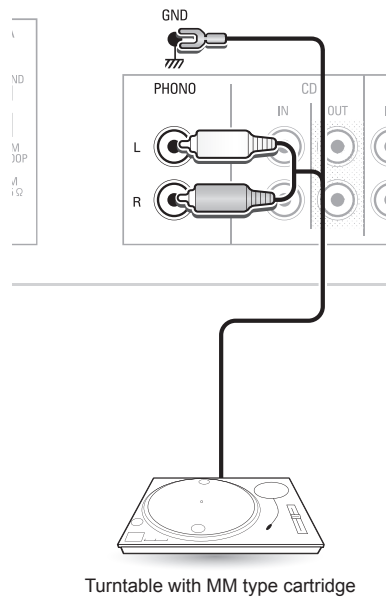

Caution

- Do not connect the turntable with MC type cartridge directly. If so, use a separate head amplifier or step-up transformer.

Listening with Headphones

- 1 Connect the headphones to the PHONES jack on the front panel.

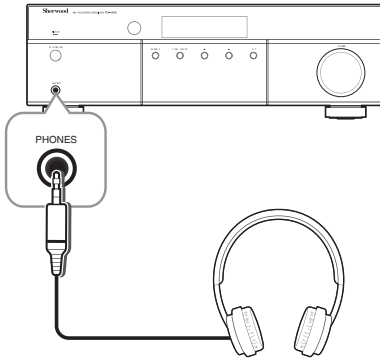

! Caution

- Be careful not to set the volume too high when using headphones.

Connecting Recording Components

You can connect audio recording devices to the AUX OUT jacks. You can make an audio recording from the built-in tuner or from an audio source connected to the main unit.

Rear Panel

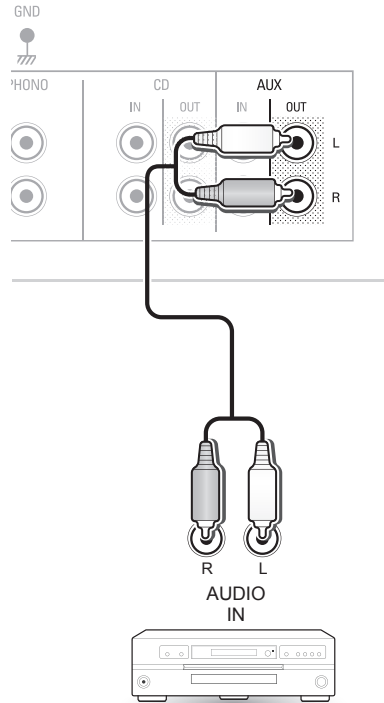

Connecting an Antenna

To listen to radio stations, connect the FM wire antenna and AM loop antenna as illustrated below.

Connecting FM Antenna

To strengthen the signal reception, extend the antenna to its full length.

Indoor Antenna

- 1 Connect the FM indoor antenna to the FM antenna terminal.
- 2 Change the position of the antenna until you get the best reception of your favorite FM stations.

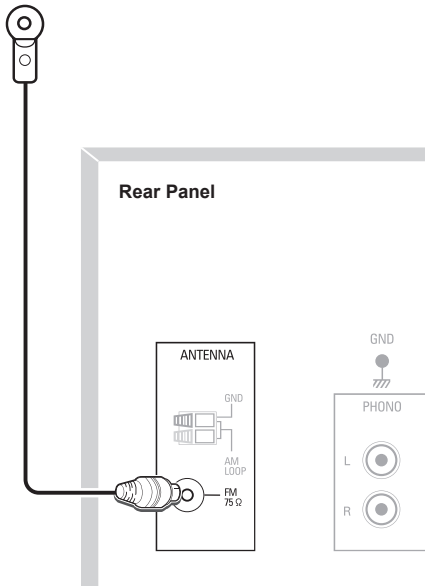

Outdoor Antenna

- 1 Remove the indoor antenna if it is connected.
- 2 Connect the FM outdoor antenna to the FM antenna terminal.

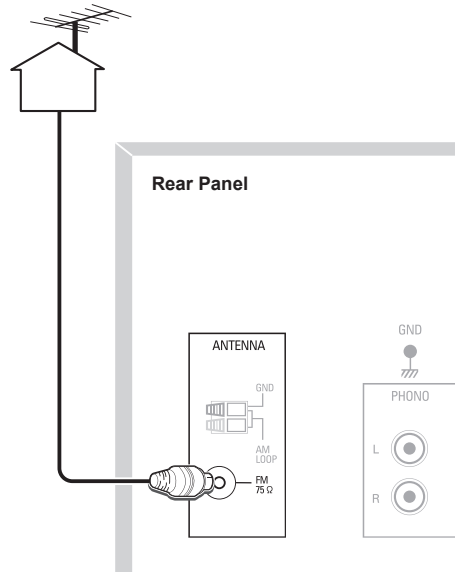

Connecting AM Antenna

- 1 Assemble the AM loop antenna as illustrated below.
- 2 Place the antenna as far as possible from the main unit, TV set, speaker cords and the AC input cord, and set the direction for the best reception.
- 3 If the reception is poor with the AM loop antenna, it is recommended to replace it with an AM outdoor antenna.

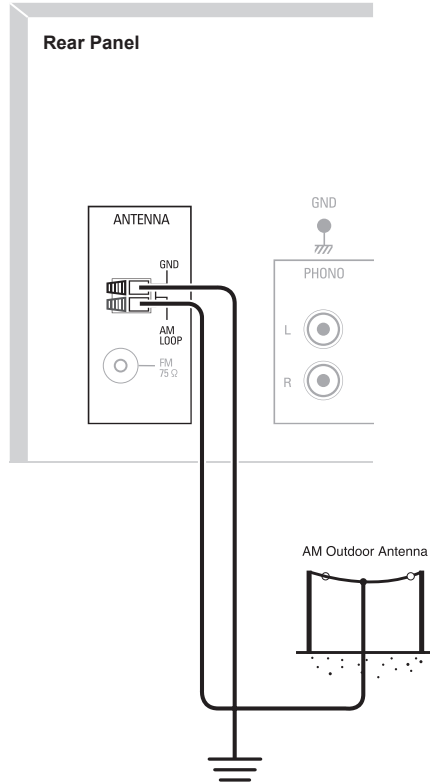
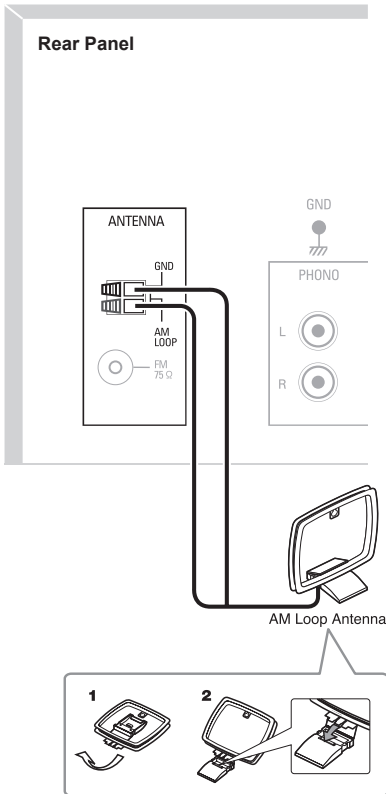

Connecting Power

Make sure to plug in only after you have connected all your components to the main unit. Plug the supplied AC power cord into the wall outlet.

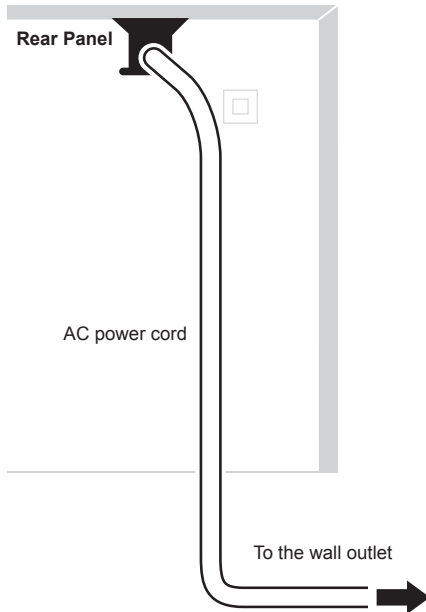

Operating Your System

Listening to Your System

Basic Operation

You can listen to audio by following the basic procedures below.

- 1 Turn on the connected component.
- 2 Turn on the main unit.
 - On the main unit, press **ON/STANDBY**.
 - On the remote control, press **POWER**.

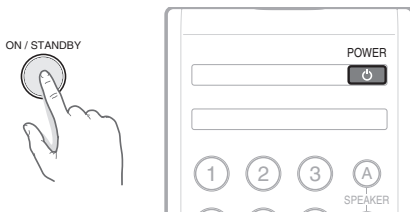

Note

- With the receiver in Standby mode, you can also turn the power on by pressing an Input Selector button on the remote control.

- 3 Select the speakers you want to play.
 - On the remote control, press **SPEAKER A** or **SPEAKER B**. "SPK A(or/and)B" is displayed.

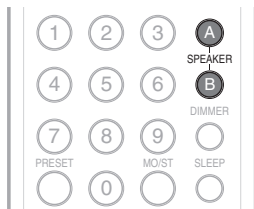

Note

- When using the headphone, press the corresponding speaker button to switch off both A and B speakers.

- 4 Select the input source you want to play back.
 - On the main unit, press **INPUT**.
 - Each time the button is pressed, the display changes in the following order:

FM → AM → CD → AUX →
PHONO → Bluetooth AUDIO
 - On the remote control, press a source select button.

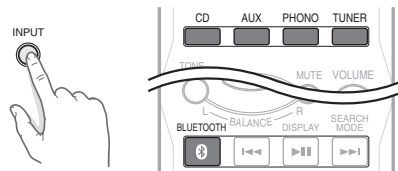

- 5 Start playback of the component you selected in step 1.
- 6 During playback, you can adjust the volume level.
 - On the main unit, rotate the volume controller.
 - On the remote control, press **VOLUME +/-**.

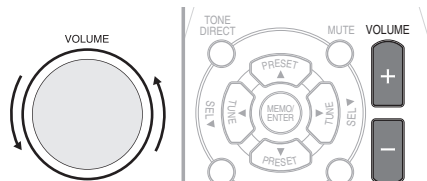

Muting the Sound

You can mute the sound temporarily by pressing **MUTE**.

- 1 Press **MUTE** to mute the sound.

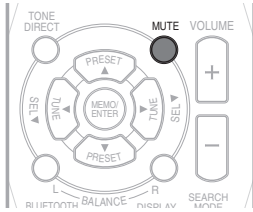

- 2 Press **MUTE** or **VOLUME - / +** to turn on the sound.

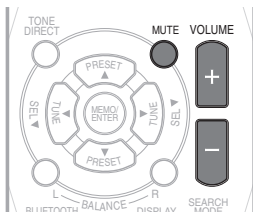

Adjusting the Sound Balance (Left and Right)

- 1 Adjust the sound volume balance between the left and right speakers by pressing **L-BALANCE** or **BALANCE-R**.
 - The each sound balance level can be adjusted up to 10.
 - It is recommended the balance to be adjusted to 0.

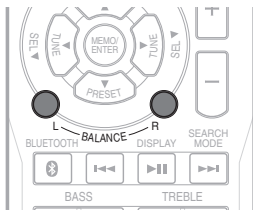

Adjusting the Tone (Bass and Treble)

You can adjust the tone (bass and treble) as desired.

- 1 Select the tone control mode by pressing **TON DIRECT**.

- "TON CTRL" is displayed on the display panel.

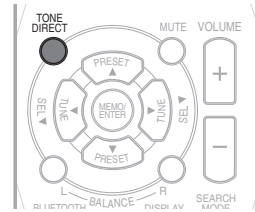

Note

- If you want to listen to a program source without the tone effect, select the tone direct mode by pressing **TON DIRECT**. "TON DIR" and "DIR." are displayed on the display panel.

- 2 Adjust the tone as desired by pressing **BASS +/-** or **Treble +/-**.

- The tone level can be adjusted within the range of -10 ~ +10 dB.
- It is recommended the bass and treble to be adjusted to 0 dB (flat level).

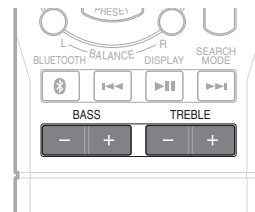

Caution

- Extreme settings at high volume may damage your speakers.

Listening to Radio

Selecting the Band

- 1 Select **FM** or **AM** tuner as the input source.
 - On the main unit, press **INPUT** repeatedly.
 - On the remote control, press **TUNER** repeatedly.

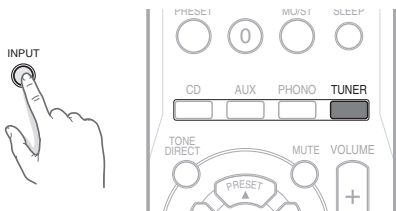

Note

- When FM stereo broadcasts are poor, select FM mono mode to reduce the noise. For details, see "Switching FM Stereo/Mono Mode" on page 20.

Manual Tuning

- 1 Select a desired station.
 - On the main unit, press ◀ or ▶ repeatedly.
 - On the remote control, press **TUNE** ◀ or **TUNE** ▶ repeatedly.

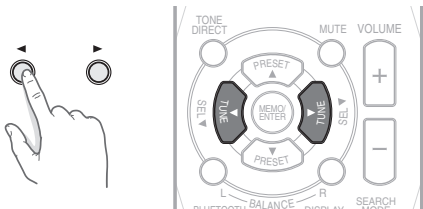

Auto Tuning

- 1 Press and hold **TUNE** ◀ or **TUNE** ▶ for more than 1 second.
 - On the main unit, press and hold ◀ or ▶ for more than 1 second.
 - The tuner keeps searching until a station with strong signal strength is found. The display shows the tuned frequency.
 - If the found station is not the desired one, simply repeat this operation.
 - Stations with weak signal strength are skipped during auto tuning.

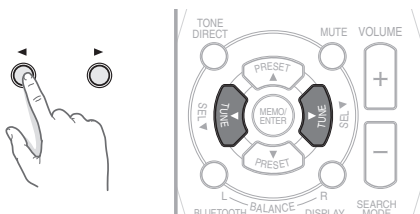

Manual Presetting

- 1 Tune to the desired station with auto or manual tuning.
- 2 Press **MEMO/ENTER**.
 - On the main unit, press **MEMORY**.
 - "AUTO MEM" blinks on the display panel.

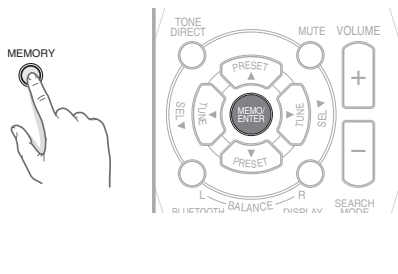

- 3** Select a desired preset number (1~30).
- On the main unit, press ◀ or ▶.
 - On the remote control, press **PRESET ▲** or **PRESET ▼**.
 - A stored station is erased from the memory by storing another station in its place.

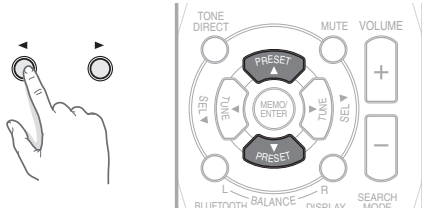

Note

- When you set a preset number by pressing numeric buttons on the remote control, you can skip the step 4.

- 4** Confirm your selection.
- On the main unit, press **MEMORY**.
 - On the remote control, press **MEMO/ENTER**.
 - The station has now been stored in the memory.
 - A stored station is erased from the memory by storing another station in its place.

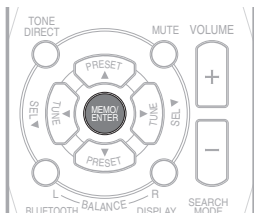

- 5** Repeat the above steps 1 - 4 to store another station.

Auto Presetting

- 1** Press and hold **MEMO/ENTER** for more than 2 seconds.
- "AUTO MEM" blinks and the main unit begins to preset stations with strong signals.
 - Up to 30 FM stations may be stored.
 - To stop auto presetting, press **MEMO/ENTER** again.

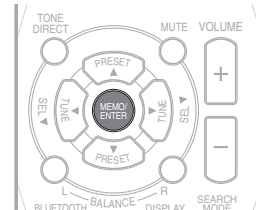

Note

- Auto preset is performed only when you select **FM** tuner as a input source.
- FM stations with weak signal strength cannot be stored to memory.

Tuning in to Preset Stations

- 1 Select a desired preset number.
 - On the main unit, press ◀ or ▶.
 - On the remote control, press **PRESET ▲** or **PRESET ▼**.

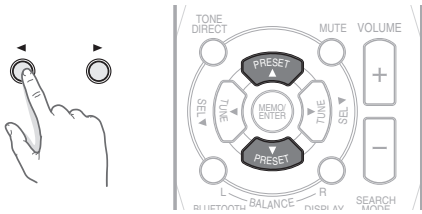

Note

- If you select a desired preset number by pressing ◀ or ▶ on the main unit, be sure to select preset mode. When you select preset mode, "PRESET" is displayed on the display panel.
- You can select a desired preset number by pressing numeric buttons on the remote control.

Scanning Preset Stations in Sequence

- 1 Press **Presets**.
 - The receiver starts scanning the stations in the preset sequence.
- 2 Press **Presets** again to stop scanning.



Note

- Stations with weak signals will not be scanned, and will therefore not be sampled.

Switching FM Stereo/Mono Mode

- 1 Select **FM** tuner as the input source.
 - On the main unit, press **INPUT** repeatedly.
 - On the remote control, press **TUNER** repeatedly.
- 2 Press the **MO/ST**.

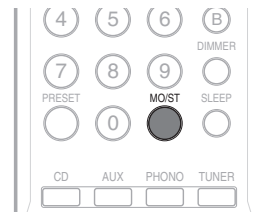

Bluetooth

Bluetooth technology is a short-range wireless technology that enables wireless data communication between digital devices. You can enjoy music wirelessly with a music player featuring Bluetooth wireless technology such as MP3 player, mobile phone, etc..

Pairing with the Bluetooth Device

- 1 Select **Bluetooth AUDIO** as the input source.
 - On the main unit, press **INPUT** repeatedly.
 - On the remote control, press **BLUETOOTH**.

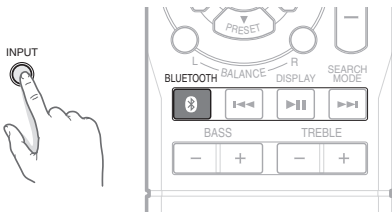

Note

- Place the device near the main unit within 30 feet (10 meters).

- 2 Perform pairing on the device to detect main unit.
 - "PAIRING" is displayed on the display panel and the Bluetooth indicator blinks.
- 3 Select "RX-4508" in the device list.
 - If "RX-4508" is not displayed, repeat from step 1.
- 4 If PIN code is required, enter "0000" on the device.



Note

- Depending on the device, connection is automatically made without enter the PIN code.

- 5 When pairing is completed, "CONNECTED" is displayed on the display panel and the Bluetooth indicator is turned on.



Note

- If the last paired device in range during pairing mode, the device will connect automatically.

Listening to Music on Device

To Pause Playback

- 1 During playback, press **▶||**.
 - Playback will stop at the point where the button is pressed.
 - To resume playback from this point, press the button again.

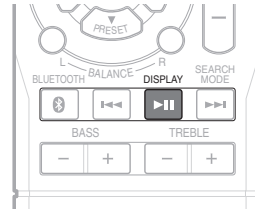

Note

- Depending on the device, "Bluetooth PAUSE" is delayed on the display panel.

To Skip Forward or Backward

- Each time the button is pressed, a track is skipped forward or backward.
 - On the main unit, press ◀ or ▶.
 - On the remote control, press ◀◀ or ▶▶.

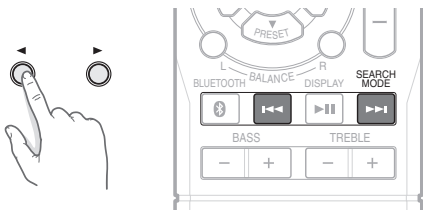

To Search Forward or Backward

- Each time the button is pressed and held, playback point is moved forward or backward.
 - On the main unit, press and hold ◀ or ▶ for more than 1 second.
 - On the remote control, press and hold ◀◀ or ▶▶ for more than 1 second.

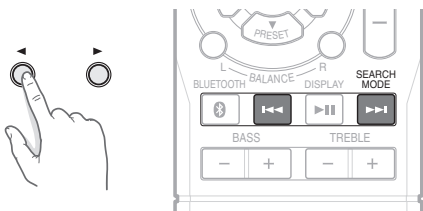

Recording

You can make an audio recording from the built-in tuner or from an audio source connected to the receiver (such as a CD player or TV).

Keep in mind you can't make a digital recording from an analog source or vice-versa, so make sure the components you are recording to/from are hooked up in the same way.

(For details on connection, see "Connecting Playback Components" on page 11.)

- The receiver's volume, Audio parameters (the tone controls, for example), and surround effects have no effect on the recorded signal.
- Some digital sources are copy-protected, and can only be recorded in analog.

- Select the desired recording source.

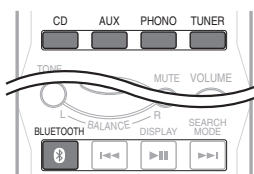

- Start recording on the component.

- Start play on the desired input.

- The audio signal from the desired input will be dubbed on the recorder and you can enjoy them from the speakers.



Note

- The volume and tone (bass and treble) settings have no effect on the recording signals.
- When recording the audio signals from AUX, cannot be recorded on the same AUX jack. (For example, the audio signal from AUX IN cannot be recorded on AUX OUT.)

Using Other Functions

Setting the Sleep Timer

You can set a specified period of time before the main unit is automatically shut.

- 1 Press **SLEEP**.
 - Each time the button is pressed, the sleep time changes as follows:

→ 10 → 20 → 30 → 60 → 90 → Off —
Unit: minutes

- While operating the sleep timer, "*)" lights up.
- When the sleep time is selected, the fluorescent display is dimly lit.



Setting the Auto Power Control

You can set the standby time for the system to be turned off. The default setting value is 6H.

- 1 Press and hold **SLEEP** for more than 3 seconds.
 - Each time this button is pressed, the auto power control time changes as follows:

→ Off → 2h → 4h → 6h —



Note

- When you play music via Bluetooth, the auto power control does not work.

Adjusting the Brightness of the Fluorescent Display

You can select the brightness of the fluorescent display as desired.

- 1 Press **DIMMER**.
 - Each time the button is pressed, the display mode changes as follows:

→ On → Dimmer → Off —

- In the display Off mode, pressing any button will restore the display On mode.

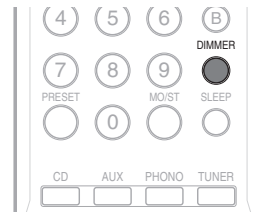

Troubleshooting

If you experience any of the following difficulties while using the system, use this troubleshooting guide to help remedy the problem before requesting servicing. Should any problem persist, consult your nearest authorized dealer or authorized independent company.

If the unit does not operate normally due to external influence such as static electricity, disconnect the power plug from the outlet and insert again to return to normal operating conditions.

GENERAL

Problem	Remedy
The power does not turn on.	<ul style="list-style-type: none"> Disconnect the power plug from the outlet, and connect again.
The system suddenly turns off.	<ul style="list-style-type: none"> After about a minute (you won't be able to turn the main unit on during this time), turn the system back on. If the problem persists, call an authorized independent service company.
No sound is heard after a function is selected.	<ul style="list-style-type: none"> Make sure the component is connected correctly. (See "Making Connections" on page 9.) Press MUTE to restore the sound.
Can't operate the remote control.	<ul style="list-style-type: none"> Replace the batteries. (See page 5.) Operate within 7 m, and 30° of the remote sensor Remove any obstacles, or operate from another position. Avoid exposing the remote sensor on the front panel to direct light.
The display is dark or off.	<ul style="list-style-type: none"> Press DIMMER on the control repeatedly to return to the default setting.

SOUND

Problem	Remedy
There is no sound from the selected component.	<ul style="list-style-type: none"> Check that the component is connected correctly to the audio input jacks of components. Ensure that the cords are fully inserted into the jacks on both the component and the main unit. Ensure that the component is selected correctly.
Sound is interrupted or there is noise.	<ul style="list-style-type: none"> Check the output audio formats support system. Check that the speakers and equipment are connected securely. Move your audio equipment away from the TV. The plugs and jacks are dirty. Wipe them with a cloth slightly moistened with alcohol.
The left and right sounds are unbalanced or reversed.	<ul style="list-style-type: none"> Ensure that the speakers and equipment are connected correctly and securely.
Recording cannot be carried out.	<ul style="list-style-type: none"> Ensure that the equipment is connected correctly. Select the source equipment using the input buttons (See page 16). Copyright protection to prevent recording is contained in the sources. In this case, you may not be able to record from the sources.
No sound, or sound suddenly ceases.	<ul style="list-style-type: none"> Check the audio output settings of the source component.

Additional Information

Specifications

Audio Section	
Power Output	100 W x 2 ch (40 Hz – 20 kHz, 8 Ohms, THD 1 % / Stereo Mode)
Input sensitivity/impedance	Phono(MM): 2.5 mV / 47k ohms Line(CD, AUX): 200 mV / 47k ohms
Signal-to-noise ratio (IHF-A)	Phono(MM): 65 dB Line(CD, AUX): 93 dB
Frequency response	Phono(MM), RIAA: 30 Hz – 20 kHz : ± 3 dB Line(CD, AUX): 10 Hz – 95 kHz : ± 3 dB
Bass/Treble control	± 10 dB
FM Tuner Section	
Frequency range	87.5 – 108.0 MHz
Usable sensitivity (S/N = 30 dB)	12 dBu
Signal-to-noise ratio (mono/stereo)	55 dBu / 50 dBu
Distortion (mono/stereo)	0.7 % / 1.0 %
Stereo separation	30 dBu @ 1 kHz
Image rejection	20 dB
IF rejection	65 dB
AM Tuner Section	
Frequency range	522 – 1611 kHz
Signal-to-noise ratio	35 dB
Usable sensitivity (S/N = 20 dB)	63 dBu/m
Selectivity (± 10 kHz)	23 dB
IF rejection	40 dB

Bluetooth Section	
Model name	IK-CSR8645
Out Power	-6 – 4 dBm
Frequency Range	2402 – 2480 MHz
General Specifications	
Power requirement	AC 230V / 50 Hz
Power consumption	230 W
Dimensions (W×H×D, including protruding parts)	17.1" x 5.5" x 14.7" (435 mm x 141 mm x 375 mm)
Weight (Net)	16.3 lb (7.4 kg)

Trademarks and Licenses

This system incorporates a sophisticated technology that allows you to create optimum sound quality and sound atmosphere in your personal Home Theater.



The *Bluetooth*® word mark and logos are registered trademarks owned by Bluetooth SIG, Inc. and any use of such marks by Inkel is under license. Other trademarks and trade names are those of their respective owners.



© 2014 CSR plc and its group companies.

The aptX® mark and the aptX logo are trade marks of CSR plc or one of its group companies and may be registered in one or more jurisdictions.



RX-4508

AM/FM STEREO RECEIVER

5707-00000-935-05

 **Sherwood**

Printed in Vietnam